

Date

Name

Client

Project Name

Quote#

Type/Quantity

SUPER-OH! 70 DOWN-UP 82720

308 07 06 822

[Weblink](#)

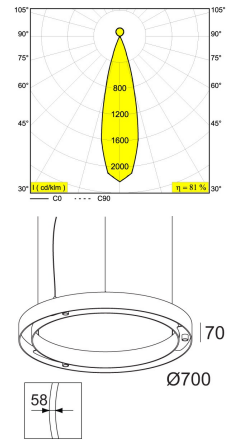

Available colors: BLACK (308 07 06 822 B)

- INCL.3 x LED WHITE DOWN 6W / CRI>80 / 2700K / 558lm
- INCL.3 x LENS FL-20° (DOWN)
- INCL.3 x LED WHITE UP 3W / CRI>80 / 2700K / 331lm
- INCL.3 x DIMMABLE LED POWER SUPPLY 500mA-DC
- INCL.3 x CABLE SUSPENSION SINGLE AUTO. 3m
- INCL.1 x CABLE 2 x 0.75mm²
- CABLING 1 CIRCUIT
- MAINS DIMMING - TRAILING EDGE

LED Technics: Light source: 2667 lm // 27 W // 99 lm/W
Luminaire: 2158 lm // 31 W // 69 lm/W

220-240V / 0|50-60Hz

Class: II

Weight: 5.8 KG
Protection level: IP20
Minimum distance: n.a.

Options: CABLE BASE R / S
COVERSET R 62-90-100 / S 62-80-90
CENTRAL SUSPENSION

Accessories: SUPER-OH CLIP + SOFTENING LENS

For detailed installation instructions, please consult the manual. [308_07_0X_XXX_HAND.pdf](#)

SUPER-OH! 70 DOWN-UP 82720
308 07 06 822

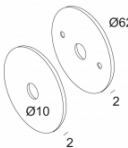
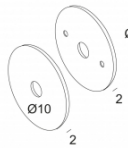
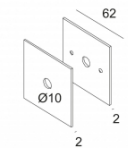
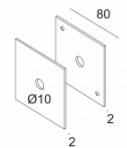
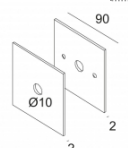

Related references

COVERSETS

<p>Weblink / Specsheet</p>  <p>COVERSET R 62 204 00 62</p>	<p>Weblink / Specsheet</p>  <p>COVERSET R 90 204 00 90</p>	<p>Weblink / Specsheet</p>  <p>COVERSET S 62 204 62 62</p>	<p>Weblink / Specsheet</p>  <p>COVERSET S 80 204 80 80</p>
<p>Weblink / Specsheet</p>  <p>COVERSET S 90 204 90 90</p>			

Related references

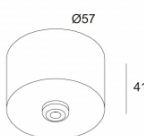
SUSPENSION PARTS

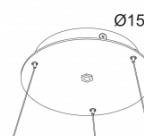
<p>Weblink / Specsheet</p>  <p>CABLE BASE R 203 99 55</p>	<p>Weblink / Specsheet</p>  <p>CABLE BASE S 203 99 56</p>	<p>Weblink / Specsheet</p>  <p>CENTRAL SUSPENSION 328 23 23</p>
--	--	--

Related references

LIGHT ALTERING DEVICES

[Weblink / Specsheet](#)

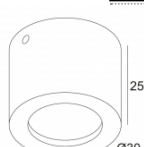

SUPER-OH! CLIP + SOFTENING LENS
201 35 00

SUPER-OH! 70 DOWN-UP 82720
308 07 06 822

Related project picture of product family:

